



DISTRIBUTED BY



ENTERPRISES LTD.

1-800-361-5361

# Alfa Laval LKB and LKB-F

## Butterfly valves

### Introduction

The Alfa Laval LKB Butterfly Valve is a reliable, hygienic in-line valve for routing low and medium-viscosity liquids in stainless steel pipe systems due to its substantial opening area and low flow resistance. The LKB is available with a standard handle with spring-locking action for straightforward manual operation or with a pneumatic actuator for pneumatic operation.

### Application

This hygienic valve is designed for on-off duties with low to medium-viscosity liquids in hygienic applications across the dairy, food, beverage, brewery and many other industries.

### Benefits

- Versatile, highly modular, hygienic design
- Reliable, cost-effective performance
- Easy to configure in either a manual version or a pneumatic version

### Standard design

The LKB Butterfly Valve consists of two valve body halves, valve disc, and bushings for the disc stem and a seal ring. These components are assembled by means of screws and nuts. The valve comes with standard weld ends but can also be supplied with fittings. The valve can also be fitted with the Alfa Laval ThinkTop® V50 and V70 for sensing and control of the valve.

The valve is available in these dimension standards: the LKB for ISO and the LKB-2 for DIN tubes. The LKB is also available in a flange version, the LKB-F, with two flanges and two flange seal rings for easy removal of the valve body without dismantling further piping setups.

The actuator is available in two versions, the LKLA and the LKLA-T (T for mounting of an indication or control unit on the actuator) and in two sizes,  $\varnothing$  3.35" and  $\varnothing$  5.24", to cover all valve requirements. The actuator is fitted onto the valve using a



bracket and screws. A handle for manual operation is fitted onto the valve by means of a cap/block system and a screw.

### Working principle

The Alfa Laval LKB Butterfly Valve can be operated either by means of a pneumatic actuator from a remote location or manually operated by means of a handle. The actuator comes in three standard versions: normally closed (NC); normally open (NO); and, air/air activated (A/A).

For pneumatic operation, an actuator converts axial piston motion into a 90° rotation of the shaft. The actuator torque increases as the valve disc comes into contact with the seal ring of the butterfly valve to secure proper closing of the valve seat.

For manual operation, a handle mechanically locks the valve in open or closed position. Two-position, four-position, regulating 90°-position, and multi-position handles are available. Manual

valves can also be mounted with indication units for feedback on the valve position (open/closed).

## TECHNICAL DATA

### Valve

Max. product pressure:	145 PSI
Min. product pressure:	Full vacuum
Temperature range:	14 °F to 284 °F (EPDM) However max. 203°F when operating the valve (All seals)

### Actuator

Max. air pressure:	87 PSI
Min. air pressure, NC and NO:	60 PSI
Temperature range:	15 °F to 195 °F
Air consumption (litres free air) - ø3.35 in:	0.24 x p (bar)
Air consumption (litres free air) - ø5.24 in:	0.95 x p (bar)
Weight:	- ø3.35 in: 6.6 lbs - ø5.24 in: 26.4 lbs

### ATEX

Classification:	II 2 G D <sup>1</sup>
-----------------	-----------------------

<sup>1</sup> This equipment is outside the scope of the directive 2014/34/EU and must not carry a separate CE marking according to the directive as the equipment has no own ignition source

## PHYSICAL DATA

### Valve bodies

Product wetted steel parts:	1.4307 (304L) or 1.4404 (316L)
Disc:	1.4301 (304) or 1.4404 (316L)
Other steel parts:	1.4301 (304)
Rubber grades:	Q, EPDM, FPM, HNBR <sup>1</sup> or PFA <sup>1</sup>
Bushes for valve disc:	PVDF
Finish:	Semi-bright
Inside surface finish:	≤ Ra 32µin

<sup>1</sup> LKB-F (DIN) with HNBR and LKB-F (DIN & ISO) with PFA are supplied with EPDM flange seal.

### Actuator


Actuator body:	1.4307 (304L)
Piston:	Light alloy (for ø3.35 in: Bronze) Air/air version
Seals:	NBR

## Options

- Tri-Clamp® or butt weld ends standard - other connections available upon request
- ThinkTop® for control and indication<sup>1</sup>
- Green Top - position indication MS or PS
- Indication unit with micro switches<sup>1</sup>
- Indication unit with inductive proximity switches<sup>1</sup>
- Handle with two or four positions (standard on 6")
- Handle for electrical position indication
- Handle with infinite intermediate positions (not for 6")

<sup>1</sup> For further information see Product Catalogue chapter "Control & Indication"

- Multi-positioning handle with lever handle or pull knob
- Service tool for actuator
- Service tool for fitting 1"-1.5" valve discs

 **Note!** For further details, see also ESE02446.

LKB Handle Options

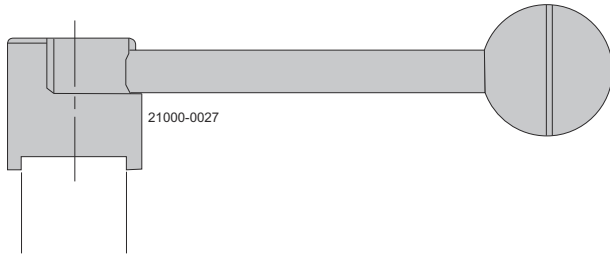


Figure 1. LKB two position handle (black handle)

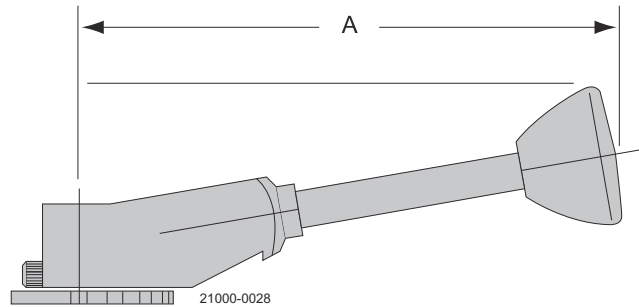


Figure 2. LKB multi-position handle (green handle)

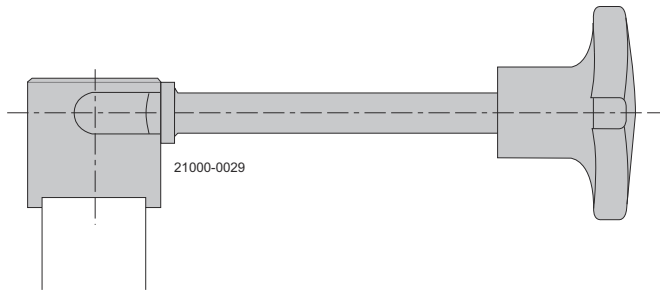


Figure 3. LKB butterfly valve regulating handle

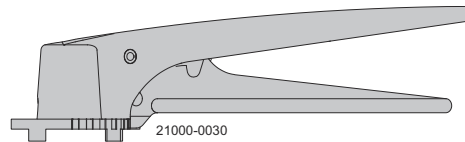
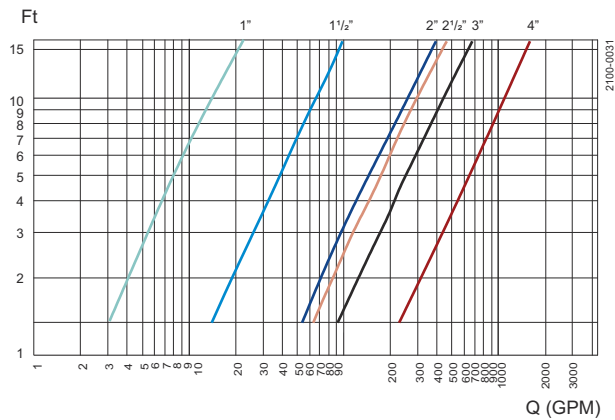



Figure 4. LKB lockable multi-position handle

Capacity/Pressure drop diagrams

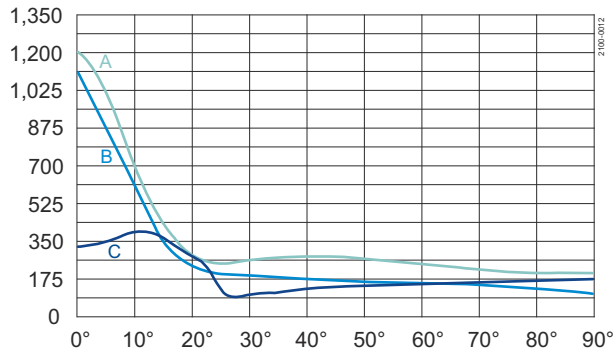


 **Note!** For the diagrams the following applies:  
 Medium: Water (68°F).  
 Measurement: In accordance with VDI 2173.

### Torque diagrams - Actuator

#### LKLA ø3.35 in:

[Inch lbs]

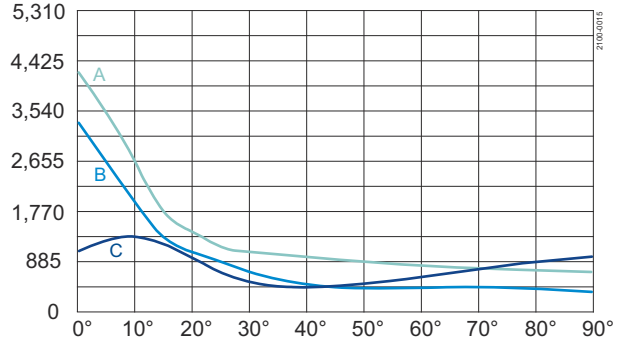


Closing - ← → Opening -  
Spring activated Air activated

A = 6 bar air pressure  
B = 5 bar air pressure  
C = Closing/opening with spring

#### LKLA ø5.25 :

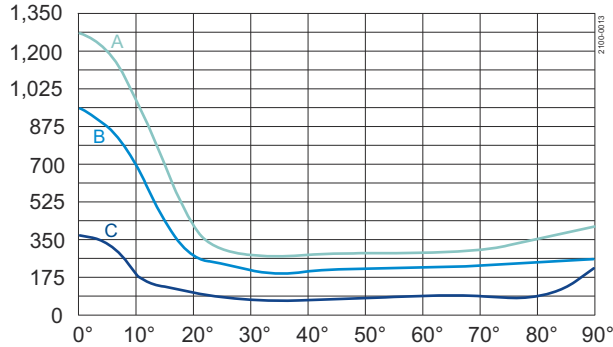
[Inch lbs]



Closing - ← → Opening -  
Spring activated Air activated

A = 6 bar air pressure  
B = 5 bar air pressure  
C = Closing/opening with spring

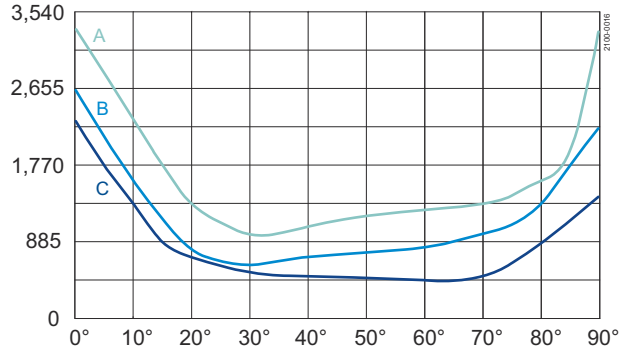
[Inch lbs]



Closing - ← → Opening -  
Air activated Spring activated

A = 6 bar air pressure  
B = 5 bar air pressure  
C = Closing/opening with spring

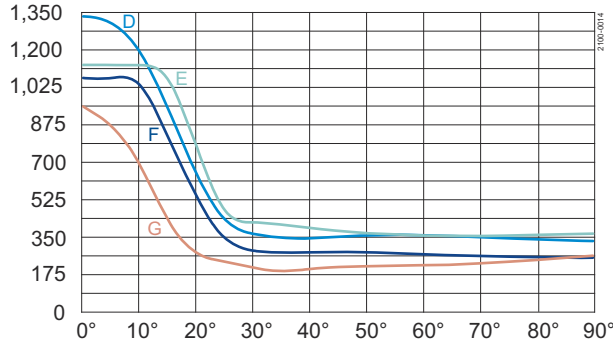
[Inch lbs]



Closing - ← → Opening -  
Air activated Spring activated

A = 6 bar air pressure  
B = 5 bar air pressure  
C = Closing/opening with spring

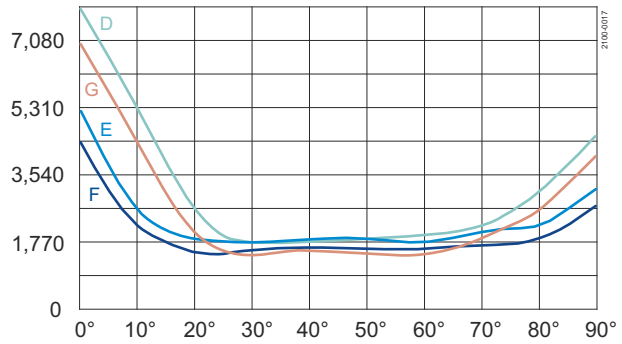
[Inch lbs]



Closing ← → Opening

D = 6 bar air pressure connection on top  
E = 6 bar air pressure connection on bottom  
F = 5 bar air pressure connection on top  
G = 5 bar air pressure connection on bottom

[Inch lbs]



Closing ← → Opening

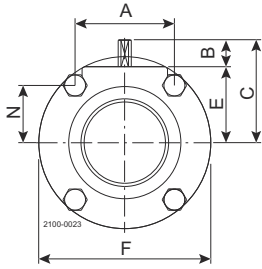
D = 6 bar air pressure connection on top  
E = 6 bar air pressure connection on bottom  
F = 5 bar air pressure connection on top  
G = 5 bar air pressure connection on bottom

**Torque values (for rotating the valve disc in a dry seal ring)**

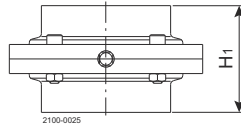
Valve Size	Max Torque (ft-lbs)
1-inch	11
1.5-inch	11
2-inch	11
2.5-inch	15
3-inch	18
4-inch	22
6-inch	26

**Valve Dimensions (inch)**

Dimensions - valve

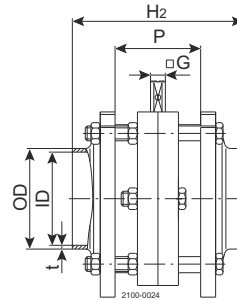


**Figure 5. LKB-F**



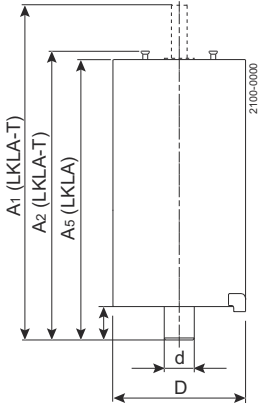
**Figure 6. LKB with welding ends**

**Note!** LKB sizes DN 125 and 150 are with six screws.



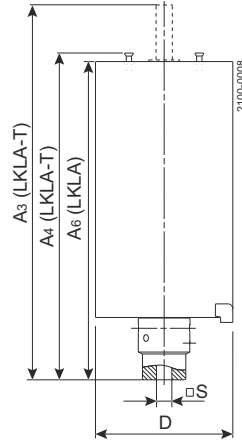
**Figure 7. LKB with male part/nut and liner**

Dimensions - actuator



**Figure 8. Without coupling**

a1 = d



**Figure 9. With coupling**

b1 = S

Dimensions - actuator

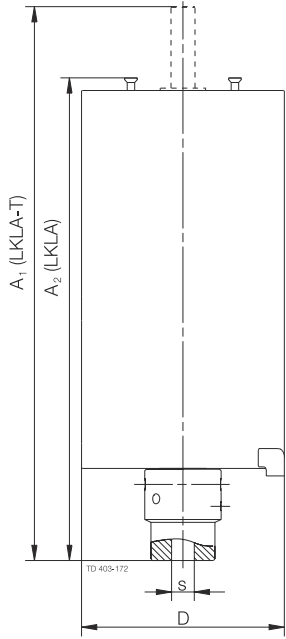


Figure 10. With coupling

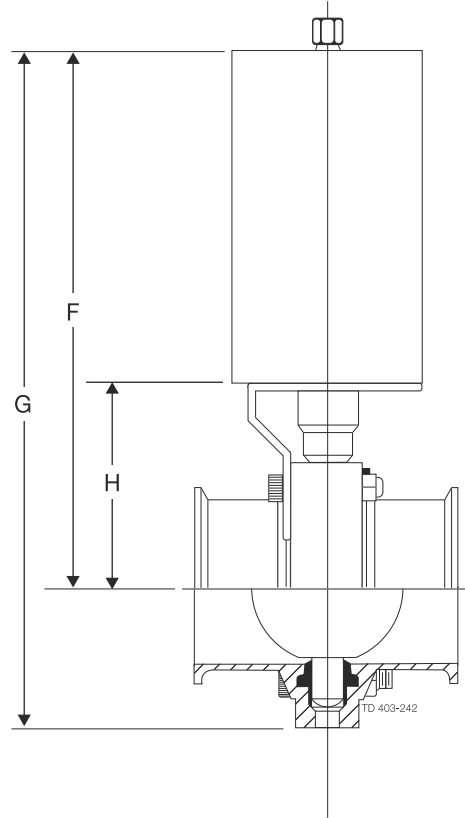


Figure 11. Mounted on a valve

Dimensions - valve

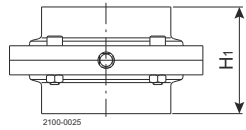


Figure 12. LKB with welding ends

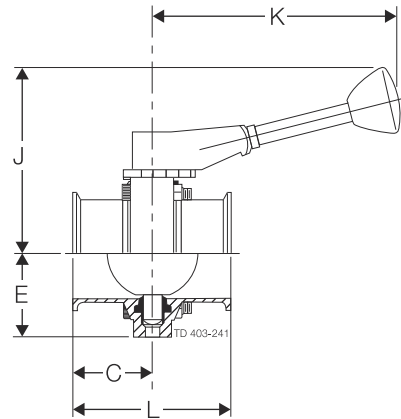


Figure 13. LKB multi-position green handle

Dimensions (inch) - Valve

Size	1"	1½"	2"	2½"	3"	4"	6"
C	1.75	1.75	1.85	1.88	2.03	2.38	3.06
L	3.50	3.50	3.70	3.76	4.06	4.76	6.12
E	1.28	1.28	1.65	2.05	2.24	3.03	4.09
F	3.07	3.07	3.90	4.61	5.20	6.65	8.50

Size	1"	1½"	2"	2½"	3"	4"	6"
H <sup>1</sup>	1.85	1.85	2.05	2.13	2.44	3.15	3.15
J (black handle)	4.72	4.72	4.72	4.72	6.38	6.38	14.17
J (green handle)	4.11	4.11	4.49	4.88	5.08	5.86	Not available
K (black handle)	4.72	4.72	4.72	4.72	6.38	6.38	14.17
K (green handle)	7.12	7.12	7.12	7.12	7.12	7.12	Not available
Weight LKB (lbs.)	2.64	2.20	3.31	4.63	10.36	19.84	-

## Dimensions (inch) - Actuator

### LKLA and LKLA-T:

Valve size	1"-2"	2.5" - 3"	4"	4"	6"	6"
A <sub>1</sub>	8.55	8.55	8.55	13.27	8.55	13.27
A <sub>2</sub>	6.83	6.83	6.83	11.42	6.83	11.42
A <sub>3</sub>	9.3	9.22	9.22	14.31	9.33	14.31
A <sub>4</sub>	7.58	7.5	7.5	12.46	7.62	12.46
A <sub>5</sub>	6.52	6.52	6.52	11.1	6.52	11.1
A <sub>6</sub>	7.26	7.19	7.19	12.15	7.3	12.15
D	3.35	3.35	3.35	5.24	3.35	5.24
d	0.67	0.67	0.67	1.18	0.79	1.18
I	0.65	0.65	0.65	1.34	0.65	1.34
S	0.31	0.39	0.47	0.47	0.59	0.59
Function	NC,NO,A/A	NC,NO,A/A	NC,NO,A/A	NC,NO,A/A	A/A	NC,NO,A/A

## Connections

### Compressed air

R1/8" (BSP), internal thread. (Quick connect fittings for ¼" tubing provided as standard)

DISTRIBUTED BY  
  
**HARCO**  
**ENTERPRISES LTD.**  
 1-800-361-5361



This document and its contents are subject to copyrights and other intellectual property rights owned by Alfa Laval Corporate AB. No part of this document may be copied, re-produced or transmitted in any form or by any means, or for any purpose, without Alfa Laval Corporate AB's prior express written permission. Information and services provided in this document are made as a benefit and service to the user, and no representations or warranties are made about the accuracy or suitability of this information and these services for any purpose. All rights are reserved.

200002159-4-EN-US

© Alfa Laval Corporate AB

### How to contact Alfa Laval

Up-to-date Alfa Laval contact details for all countries are always available on our website at [www.alfalaval.com](http://www.alfalaval.com)