



## Pneumatically operated 2/2-way angle seat valve CLASSIC

- Stainless steel or gunmetal housing with threaded, clamped or welded connection
- Long service life
- High flow rate
- Robust actuators with modular accessory program

Product variants described in the data sheet may differ from the product presentation and description.

### Can be combined with

	<b>Type 8644</b> AirLINE SP electropneumatic automation system	▶
	<b>Type 8640</b> Modular valve island for pneumatics	▶
	<b>Type 8697</b> Pneumatic control unit for decentralised automation of process valves ELEMENT	▶
	<b>Type 7012</b> Direct-acting 3/2-way plunger valve	▶
	<b>Type 6014</b> Plunger valve 3/2-way direct-acting	▶
	<b>Type 8840</b> Modular process valve cluster - distributor and collector	▶

### Type description

The externally piloted angle seat valve is operated with a single or double-acting piston actuator. The actuator is available in two different materials, depending on the ambient temperature. High flow rates are attained with the virtually straight flow path. The reliable self-adjusting packing gland provides high sealing integrity. These maintenance-free and robust valves can be retrofitted with a comprehensive range of accessories for position indication, stroke limitation or manual override.

## Table of contents

<b>1. General technical data</b>	<b>4</b>
<b>2. Product versions</b>	<b>5</b>
2.1. Gunmetal body with PA actuator .....	5
2.2. Stainless steel body with PA actuator .....	5
2.3. Stainless steel body with PPS actuator .....	5
<b>3. Control functions</b>	<b>6</b>
<b>4. Approvals and conformities</b>	<b>7</b>
4.1. General notes .....	7
4.2. Conformity .....	7
4.3. Standards .....	7
4.4. Explosion protection .....	7
4.5. Drinking water .....	7
4.6. Foods and beverages/Hygiene .....	8
4.7. Others .....	8
Oxygen .....	8
Fuel gases .....	8
<b>5. Materials</b>	<b>9</b>
5.1. Bürkert resistApp .....	9
5.2. Material specifications .....	9
<b>6. Dimensions</b>	<b>10</b>
6.1. Actuator .....	10
Angle seat valve Type 2000 and valve system On/Off CLASSIC Type 8801-YA .....	10
6.2. Body with threaded connection .....	11
6.3. Body with welded connection .....	12
6.4. Body with clamp connection .....	13
<b>7. Performance specifications</b>	<b>14</b>
7.1. Fluidic data .....	14
Overview of fluidic data for flow below seat (for liquids, steam and gases) .....	14
Pilot pressure diagram with flow direction below seat (control function B, seat seal PTFE) .....	15
Overview of fluidic data with flow above seat (for gases and steam) .....	16
Pilot pressure diagram with flow direction above seat (control function A, seat seal PTFE) .....	17
7.2. Operating limits .....	18
Operating limits for medium temperature and operating pressure .....	18
Operating limits for ambient and medium temperature .....	19
Operating limits for optional versions .....	19
<b>8. Product accessories</b>	<b>20</b>
<b>9. Networking and combination with other Bürkert products</b>	<b>21</b>

<b>10. Ordering information</b>	<b>22</b>
10.1. Bürkert eShop .....	22
10.2. Bürkert product filter .....	22
10.3. Bürkert Product Enquiry Form .....	22
10.4. Ordering chart threaded connection .....	23
Valve with flow direction below seat .....	23
Valve with flow direction above seat .....	24
10.5. Ordering chart welded connection .....	25
Valve with flow direction below seat .....	25
Valve with flow direction above seat .....	26
10.6. Ordering chart clamp connection .....	27
Valve with flow direction below seat .....	27
Valve with flow direction above seat .....	28
10.7. Ordering chart accessories .....	29
Accessories for 3/2-way pilot valves with banjo bolts .....	29

DTS 1000444947 EN Version: S Status: RL (released | freigegeben | validé) printed: 20.03.2024

## 1. General technical data

Product properties	
Dimensions	Further information can be found in chapter "6. Dimensions" on page 10.
Material	Further information can be found in chapter "5. Materials" on page 9.
Design	Angle seat valve
Nominal diameter (port connection)	DN 10...DN 80, NPS ¾...NPS 3
Safety setting in case of power failure	Normally closed (control function A), normally open (control function B)
Flow direction	Flow to open (below seat), flow to close (above seat)
Performance data	
Operating pressure	0...25 bar(g), vacuum up to -0.9 bar(g) (option) (see "7.1. Fluidic data" on page 14)
Nominal pressure	PN 25 (DIN EN 1333), Class 150 (DIN EN 1759)
Pilot pressure	2...10 bar(g) (see "7.1. Fluidic data" on page 14)
Seat leakage	Leakage rate A (according to DIN EN 12266 - 1), seat seal PTFE and PEEK, test medium air
K <sub>v</sub> value	3.8...140 m <sup>3</sup> /h (see "7.1. Fluidic data" on page 14)
Medium data	
Medium	Steam, water, neutral gases, alcohols, oils, fuels, hydraulic fluids, salt solutions, alkalis, organic solvents, oxygen and fuel gases of families I, II and III in accordance with the Gas Appliances Regulation (EU) 2016/426
Medium temperature	-40...+230 °C (see "7.2. Operating limits" on page 18)
Viscosity	Max. 600 mm <sup>2</sup> /s
Control medium	Air, neutral gases
Process/Port connection & communication	
<b>Port connection</b> <sup>1.)</sup>	
Threaded connection	G (DIN ISO 228 - 1) NPT (ASME B1.20.1) RC (ISO 7 - 1)
Welded connection	DIN EN ISO 1127 / ISO 4200 / DIN 11866 series B DIN 11850 - 2 / DIN 11866 series A ASME BPE / DIN 11866 series C SMS 3008
Clamp connection	DIN 32676 series B (pipe: ISO 4200) DIN 32676 series A (pipe: DIN 11850 - 2) ASME BPE
<b>Pilot air port</b>	
Actuator size Ø 40 (C)	Thread G ⅜
Actuator size Ø 50 (D) ... 125 (H)	Thread G ¼
Approvals and conformities	
Further information can be found in chapter "4. Approvals and conformities" on page 7.	
Material certificate	2.2, 3.1
Environment and installation	
Ambient temperature	-40...+140 °C (see "2. Product versions" on page 5)
Degree of protection	IP67
Installation position	As required, preferably with actuator upright

1.) Others are available on request.

## 2. Product versions



### 2.1. Gunmetal body with PA actuator

<b>Product properties</b>	
Nominal diameter (port connection)	DN 10...DN 65, NPS ¾...NPS 2 ½
<b>Performance data</b>	
Operating pressure	0...16 bar(g), vacuum up to -0.9 bar(g) (option) (see "7.1. Fluidic data" on page 14)
<b>Maximum pilot pressure</b>	
Actuator size 40 (C), 50 (D), 63 (E), 80 (F)	10 bar(g)
Actuator size 100.125 (H)	7 bar(g)
<b>Medium data</b>	
Medium temperature	-40...+180 °C
<b>Product connection</b>	
Port connection	Threaded connection
<b>Environment and installation</b>	
Ambient temperature	-40...+60 °C (see "7.2. Operating limits" on page 18)



### 2.2. Stainless steel body with PA actuator

<b>Product properties</b>	
Nominal diameter (port connection)	DN 10...DN 80, NPS ¾...NPS 3
<b>Performance data</b>	
Operating pressure	0...25 bar(g), vacuum up to -0.9 bar(g) (option) (see "7.1. Fluidic data" on page 14)
<b>Maximum pilot pressure</b>	
Actuator size 40 (C), 50 (D), 63 (E), 80 (F)	10 bar(g)
Actuator size 100 (G), 125 (H)	7 bar(g)
<b>Media data</b>	
Medium temperature	-40...+185 °C
<b>Product connection</b>	
Port connection	Threaded, welded or clamp connection
<b>Environment and installation</b>	
Ambient temperature	-40...+60 °C (see "7.2. Operating limits" on page 18)



### 2.3. Stainless steel body with PPS actuator

<b>Product properties</b>	
Nominal diameter (port connection)	DN 10...DN 80, NPS ¾...NPS 3
<b>Performance data</b>	
Operating pressure	0...25 bar(g), vacuum up to -0.9 bar(g) (option) (see "7.1. Fluidic data" on page 14)
<b>Maximum pilot pressure</b>	
Actuator size 40 (C), 50 (D), 63 (E), 80 (F)	10 bar(g)
Actuator size 100 (G), 125 (H)	7 bar(g)
<b>Media data</b>	
Medium temperature	-40...+230 °C
<b>Product connection</b>	
Port connection	Threaded, welded or clamp connection
<b>Environment and installation</b>	
Ambient temperature	-40...+140 °C (continuous operation...+130 °C) (see "7.2. Operating limits" on page 18)

DTS 1000444947 EN Version: S Status: RL (released | freigegeben | valide) printed: 20.03.2024

### 3. Control functions

**⚠ WARNING**  
**Risk of damage due to bursting pipes and bursting equipment when the flow is above the seat.**  
**In the case of liquid mediums, water hammer can occur, causing pipes and the device to burst.**  
 Do not use valves with flow above the seat for liquid mediums.

Symbol	Description	
<b>Flow direction below seat for liquids, steam and gases</b>		
	<b>Control function A (CF A)</b> Pneumatically operated 2/2-way on/off valve Flow direction below seat Normally closed by spring force	
	<b>Control function B (CF B)</b> Pneumatically operated 2/2-way on/off valve Flow direction above seat Normally opened by spring force	
<b>Flow direction above seat for steam and gases</b>		
	<b>Control function A (CF A)</b> Pneumatically operated 2/2-way on/off valve Flow direction above seat Normally closed by spring force	

DTS 1000444947 EN Version: S Status: RL (released | freigegeben | validé) printed: 20.03.2024

## 4. Approvals and conformities

### 4.1. General notes

- The approvals and conformities listed below must be stated when making enquiries. This is the only way to ensure that the product complies with all required specifications.
- Not all available versions can be supplied with the below mentioned approvals or conformities.

### 4.2. Conformity



In accordance with the Declaration of Conformity, the product is compliant with the EU Directives. This includes the following directives:

- Pressure Equipment Directive 2014/68/EU
- Machinery Directive 2006/42/EG

### 4.3. Standards

The applied standards which are used to demonstrate compliance with the EU Directives are listed in the EU-Type Examination Certificate and/or the EU Declaration of Conformity.

### 4.4. Explosion protection

Approval	Description																								
 	<p><b>Optional: Explosion protection</b> As a category 2 device suitable for zone 1/21 and zone 2/22 (optional).</p> <p><b>ATEX:</b> EPS 18 ATEX 2 008 X II 2G Ex h IIC T4...T2 Gb II 2D Ex h IIIC T135 °C...T300 °C Db</p> <p><b>IECEX:</b> IECEX EPS 18.0007 X Ex h IIC T4...T2 Gb Ex h IIIC T135 °C...T300 °C Db</p> <table border="1"> <thead> <tr> <th>Temperature class</th> <th>T2</th> <th>T3</th> <th>T4</th> </tr> </thead> <tbody> <tr> <td>Permissible surface temperature</td> <td>+300 °C</td> <td>+200 °C</td> <td>+135 °C</td> </tr> <tr> <td>Ambient temperature</td> <td>-40...+80 °C</td> <td>-40...+80 °C</td> <td>-40...+80 °C</td> </tr> <tr> <td>Restrictions from the device</td> <td></td> <td></td> <td></td> </tr> <tr> <td>Maximum medium temperature</td> <td>+230 °C</td> <td>+185 °C</td> <td>+125 °C</td> </tr> <tr> <td>Restrictions from the device</td> <td></td> <td></td> <td></td> </tr> </tbody> </table>	Temperature class	T2	T3	T4	Permissible surface temperature	+300 °C	+200 °C	+135 °C	Ambient temperature	-40...+80 °C	-40...+80 °C	-40...+80 °C	Restrictions from the device				Maximum medium temperature	+230 °C	+185 °C	+125 °C	Restrictions from the device			
Temperature class	T2	T3	T4																						
Permissible surface temperature	+300 °C	+200 °C	+135 °C																						
Ambient temperature	-40...+80 °C	-40...+80 °C	-40...+80 °C																						
Restrictions from the device																									
Maximum medium temperature	+230 °C	+185 °C	+125 °C																						
Restrictions from the device																									

### 4.5. Drinking water

Conformity	Description
	<p><b>Suitable for use in drinking water applications</b> The materials comply with the assessment principles (UBA) for materials in contact with drinking water (TrinkwasserV).</p> <p><b>Gunmetal body/stainless steel body</b> PF39: Suitable for products with medium temperature up to 85 °C (hot water)</p>

DTS 1000444947 EN Version: S Status: RL (released | freigegeben | validé) printed: 20.03.2024

**4.6. Foods and beverages/Hygiene**

Conformity	Description
FDA	<b>FDA – Code of Federal Regulations (valid for the variable code PL02)</b> All wetted materials are compliant with the Code of Federal Regulations published by the FDA (Food and Drug Administration, USA) according to the manufacturer’s declaration.
	<b>EC Regulation 1935/2004 of the European Parliament and of the Council (valid for the variable code PL01, PL02)</b> All wetted materials are compliant with EC Regulation 1935/2004/EC according to the manufacturer’s declaration.

**4.7. Others**

**Oxygen**

Conformity	Description
	<b>Optional: Suitability for oxygen (valid for the variable code NL02)</b> The products are suitable for use with gaseous oxygen, according to the manufacturer’s declaration.

**Fuel gases**

Conformity	Description
	<b>Fuel gases (valid for the variable code PO19, PO20)</b> The products comply with: <ul style="list-style-type: none"> <li>• Regulation (EU) 2016/426 – Appliances burning gaseous fuels and</li> <li>• DVGW DIN EN 161 (Automatic shut-off valves for gas burners and gas appliances) and</li> <li>• DIN EN 16678, Class A or Class D (Safety and control devices for gas burners and gas burning appliances – Automatic shut-off valves for operating pressure of above 500 kPa up to and including 6 300 kPa)</li> </ul>

DTS 1000444947 EN Version: S Status: RL (released | freigegeben | valide) printed: 20.03.2024



## 5. Materials

### 5.1. Bürkert resistApp

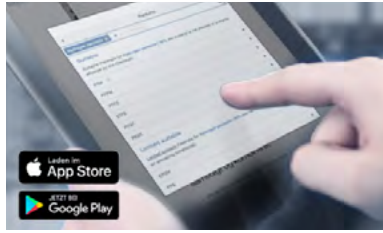

#### Bürkert resistApp – Chemical resistance chart

You want to ensure the reliability and durability of the materials in your individual application case? Verify your combination of media and materials on our website or in our resistApp.

[Start chemical resistance check](#)

### 5.2. Material specifications

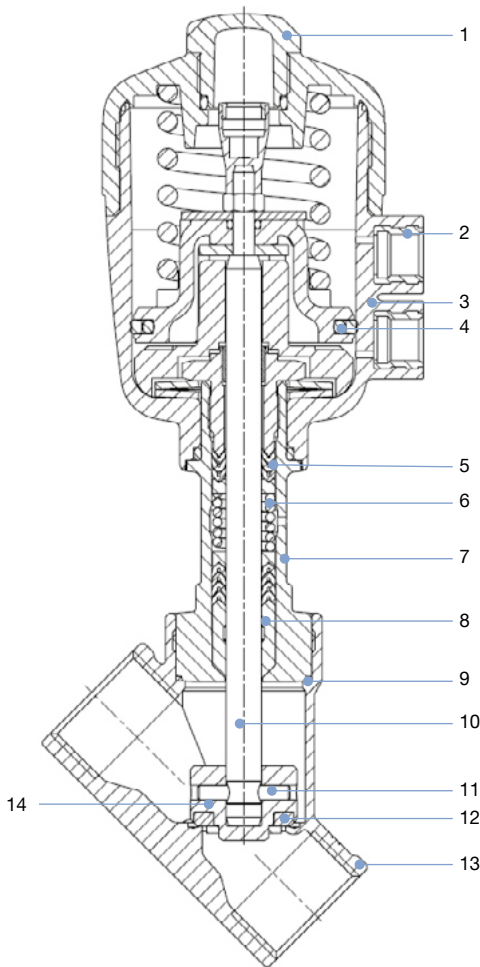

No.	Element	Material		
		Gunmetal body with PA actuator	Stainless steel body with PA actuator      with PPS actuator	
1	Transparent cover	PC	PC	PSU
2	Pilot air ports	Stainless steel 1.4305		
3	Actuator	PA	PA	PPS
4	Piston seal	NBR	NBR	FKM
5	Spindle sealing	PTFE V-Rings (filled), with spring compensation		
6	Spring	Stainless steel 1.4310		
7	Pipe <sup>1.)</sup>	Brass	Stainless steel 1.4401 Stainless steel 316L <sup>2.)</sup>	Stainless steel 1.4401 Stainless steel 316L <sup>2.)</sup>
8	Wiper	PTFE (filled), PEEK <sup>3.)</sup>		
9	Body seal	Graphite, PTFE (option)		
10	Spindle	Stainless steel 1.4401 or 1.4404		
11	Pin	Stainless steel 1.4401 or 1.4404		
12	Seat seal	PTFE, PEEK (option), NBR (option), FKM (option)		
13	Valve body	Gun metal	Stainless steel 316L/CF3M	
14	Swivel plate	Brass	Stainless steel 1.4401 or 1.4404	

1.) In one piece for the actuator size 63 mm (E), 80 mm (F), 100 mm (G) and 125 mm (H)

2.) For the actuator sizes 63 mm (E), 80 mm (F), 100 mm (G) and 125 mm (H)

3.) For the actuator sizes 100 mm (G) and 125 mm (H)

## 6. Dimensions

### 6.1. Actuator

Angle seat valve Type 2000 and valve system On/Off CLASSIC Type 8801-YA

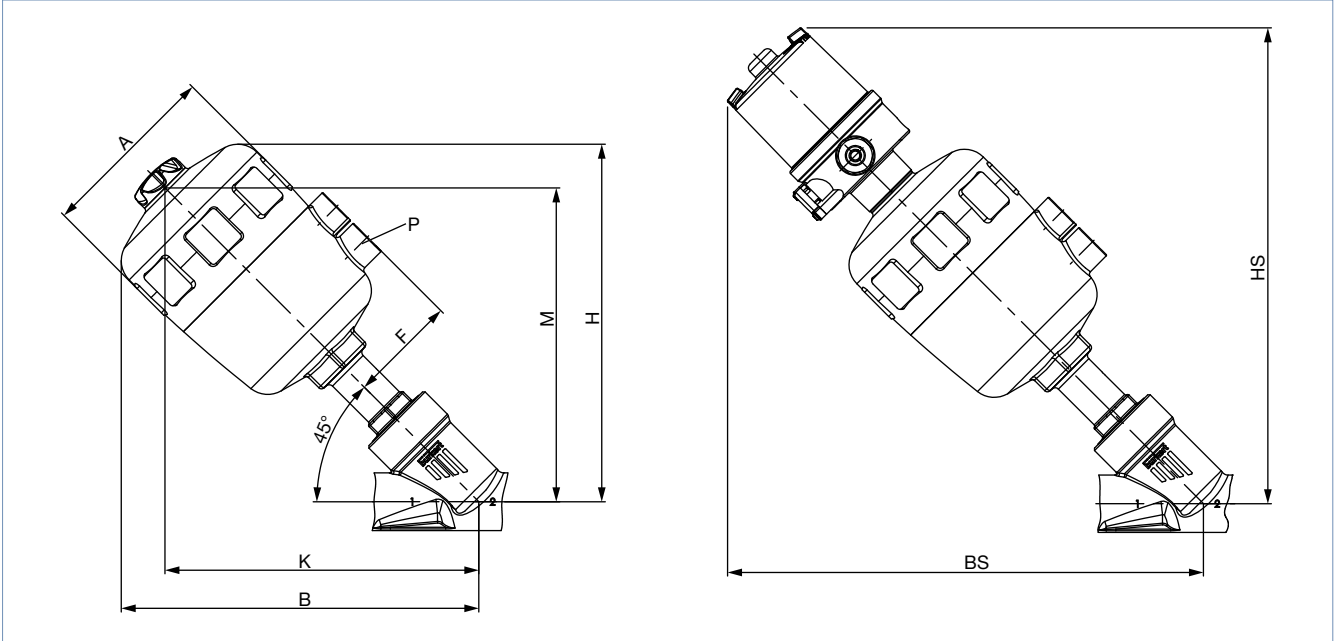

Nominal diameter (port connection)		Actuator size Ø	Ø A	B / H <sup>1.)</sup>	K / M <sup>1.)</sup>	P	BS / HS <sup>1.)</sup>
DN	NPS		[mm]	[mm]	[mm]	[inch]	[mm]
10	3/8	40 (C)	53	127	110	G 1/8	198
		50 (D)	64	145	129	G 1/4	216
		63 (E)	80	177	158	G 1/4	246
15	1/2	40 (C)	53	127	110	G 1/8	198
		50 (D)	64	145	129	G 1/4	216
		63 (E)	80	177	158	G 1/4	246
20	3/4	40 (C)	53	130	113	G 1/8	201
		50 (D)	64	150	133	G 1/4	207
		63 (E)	80	174	155	G 1/4	243
		80 (F)	101	195	171	G 1/4	259
25	1	50 (D)	64	152	136	G 1/4	223
		63 (E)	80	178	159	G 1/4	242
		80 (F)	101	195	171	G 1/4	259
32	1 1/4	63 (E)	80	188	169	G 1/4	257
		80 (F)	101	209	185	G 1/4	273
		100 (G)	127	262	232	G 1/4	320
40	1 1/2	63 (E)	80	191	172	G 1/4	260
		80 (F)	101	213	188	G 1/4	277
		100 (G)	127	251	221	G 1/4	309
		125 (H)	158	291	254	G 1/4	342
50	2	63 (E)	80	209	190	G 1/4	278
		80 (F)	101	230	206	G 1/4	294
		100 (G)	127	277	247	G 1/4	335
		125 (H)	158	306	269	G 1/4	357
65	2 1/2	80 (F)	101	242	218	G 1/4	306
		100 (G)	127	290	260	G 1/4	348
		125 (H)	158	319	282	G 1/4	370
80	3	125 (H)	158	339	301	G 1/4	390

1.) The dimensions for B, H, K, M, HS and BS are maximum dimensions and may be up to 6 mm less, depending on the nominal diameter and standard.

6.2. Body with threaded connection

Note:  
Dimensions in mm

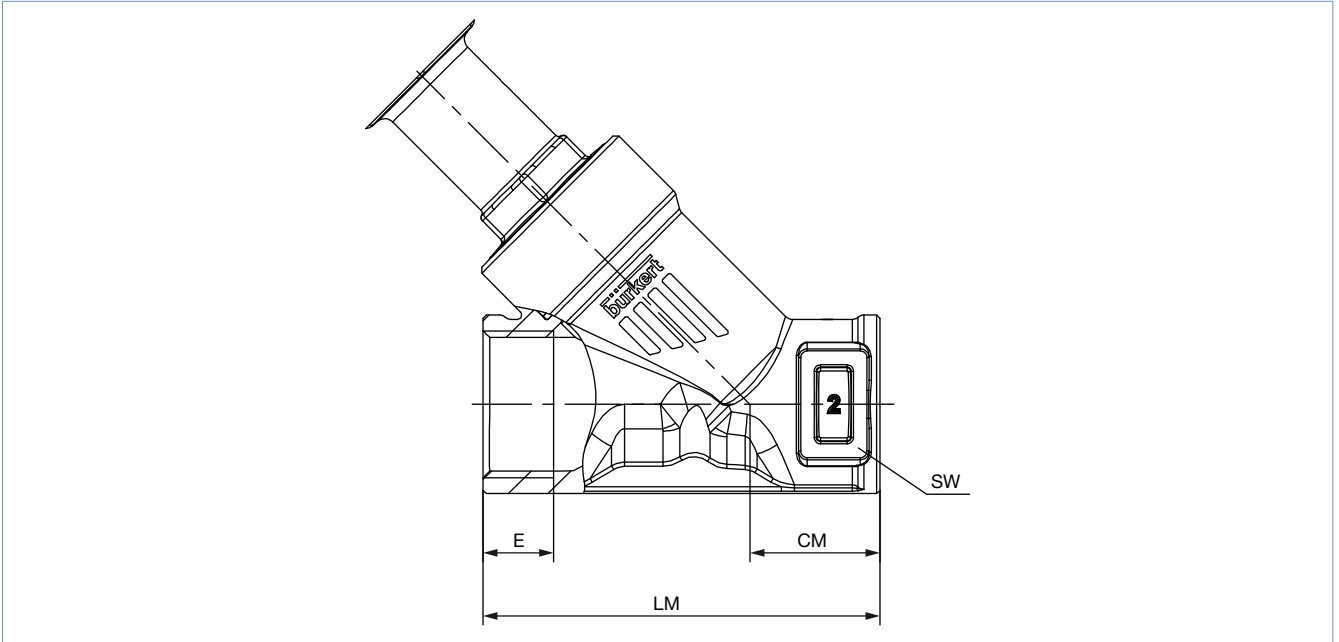

Nominal diameter (port connection)		G (DIN ISO 228 - 1) NPT (ASME B1.20.1) RC (ISO 7 - 1)					
		E			CM	LM	SW
DN	NPS	G	NPT	RC			
15	1/2	14	13.7	13.2	24	65	27
20	3/4	16	14.0	14.5	27	75	34
25	1	18	16.8	16.8	29.5	90	41
32	1 1/4	16	17.3	19.1	36	110	50
40	1 1/2	18	17.3	19.1	35	120	55
50	2	24	17.6	23.4	45	150	70
65	2 1/2	26	23.7	26.7	57	185	85
80	3	28	-	-	71	220	100

### 6.3. Body with welded connection

**Note:**

Dimensions in mm

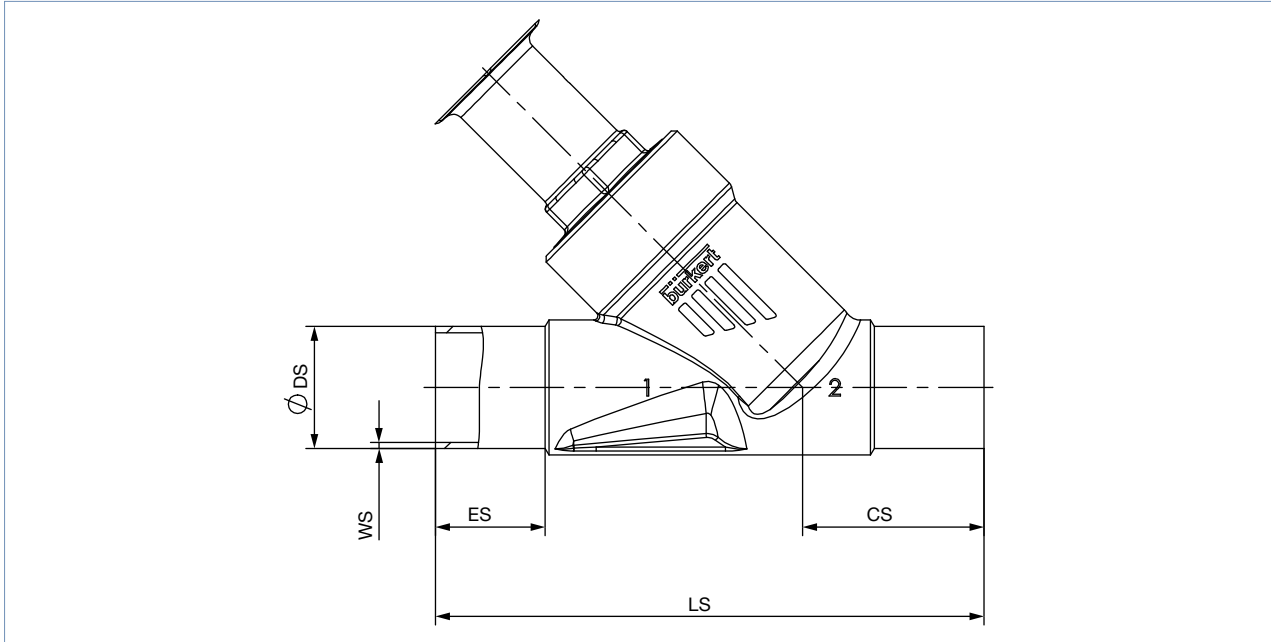

Nominal diameter (port connection)	DIN EN ISO 1127 / ISO 4200 / DIN 11866 series B					DIN 11850-2 / DIN 11866 series A				
	ES	CS	LS	Ø DS	WS	ES	CS	LS	Ø DS	WS
15	19	34	100	21.3	1.6	19	34	100	19	1.5
20	20	39	115	26.9	1.6	20	39	115	23	1.5
25	26	43	130	33.7	2.0	26	43	130	29	1.5
32	26	45	145	42.4	2.0	26	45	145	35	1.5
40	26	49	160	48.3	2.0	26	49	160	41	1.5
50	26	50	175	60.3	2.0	26	50	175	53	1.5
65	26	50	210	76.1	2.3	26	50	210	70	2

Nominal diameter (port connection)	ASME BPE / DIN 11866 series C				
NPS	ES	CS	LS	Ø DS	WS
½	30	46	135	12.7	1.65
¾	30	52	145	19.05	1.65
1	30	51	152	25.4	1.65
1½	30	60	182	38.1	1.65
2	30	64	210	50.8	1.65
2½	26	56	230	63.5	1.65

DTS 1000444947 EN Version: S Status: RL (released | freigegeben | valide) printed: 20.03.2024

### 6.4. Body with clamp connection

**Note:**

Dimensions in mm

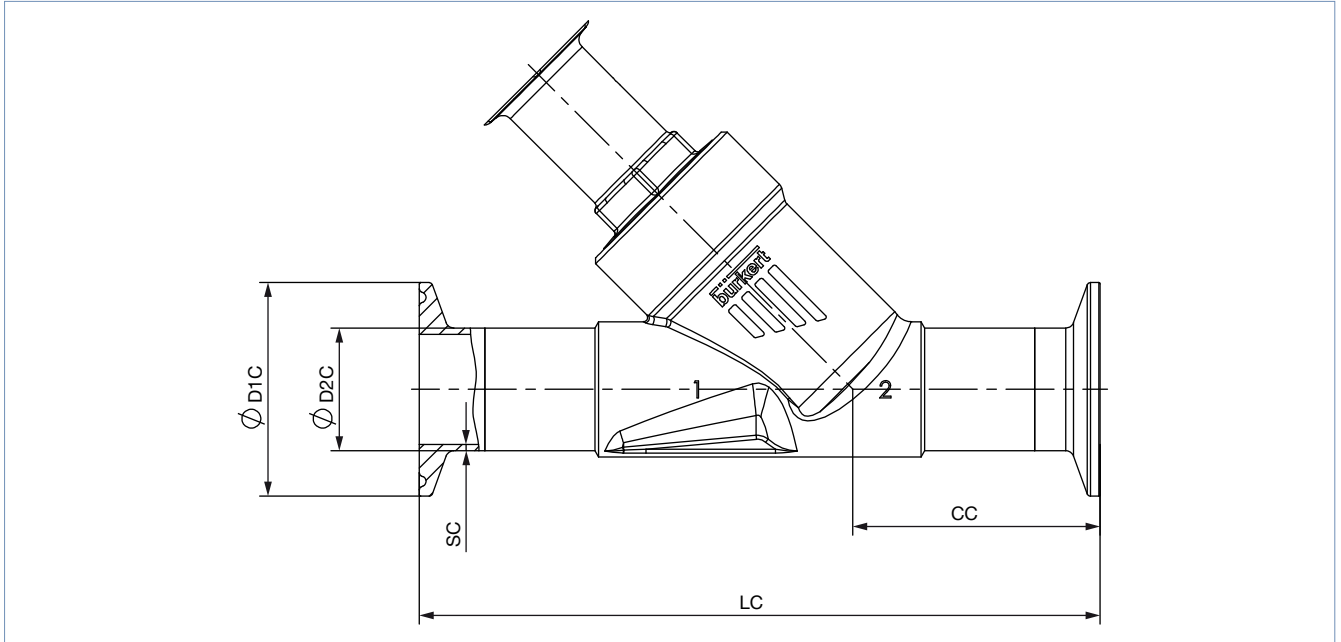

Nominal diameter (port connection)	Clamp: DIN 32676 series B Pipe: DIN EN ISO 1127 / ISO 4200 / DIN 11866 series B					Clamp: DIN 32676 A (DN 15 similar DIN 32676 series B) Pipe: DIN 11850 - 2 / DIN 11866 series A				
	DN	LC	CC	Ø D1 C	Ø D2 C	SC	LC	CC	Ø D1 C	Ø D2 C
15	156	49.0	50.5	21.3	1.6	130	49.5	34.0	19	1.5
20	150	56.5	50.5	26.9	1.6	150	57.0	34.0	23	1.5
25	160	58.0	50.5	33.7	2.0	160	58.5	50.5	29	1.5
32	200	57.5	50.5	42.4	2.0	180	58.0	50.5	35	1.5
40	200	69.0	64.0	48.3	2.0	200	69.5	50.5	41	1.5
50	230	77.5	77.5	60.3	2.6	230	78.0	64.0	53	1.5

Nominal diameter (port connection)	Clamp: ASME BPE Pipe: ASME BPE / DIN 11866 series C				
NPS	LC	CC	Ø D1 C	Ø D2 C	SC
½	130	49.0	25.0	12.7	1.65
¾	150	56.5	25.0	19.05	1.65
1	160	58.0	50.5	25.4	1.65
1½	200	69.0	50.5	38.1	1.65
2	230	77.5	64.0	50.8	1.65

DTS 1000444947 EN Version: S Status: RL (released | freigegeben | validé) printed: 20.03.2024

## 7. Performance specifications

### 7.1. Fluidic data

Overview of fluidic data for flow below seat (for liquids, steam and gases)

Note:

- $K_v$  value [m<sup>3</sup>/h]: Measured with water at +20 °C, 1 bar(g) pressure at valve inlet and free outlet
- $C_v$  value [GMP(US)] =  $K_v \times 1.156$

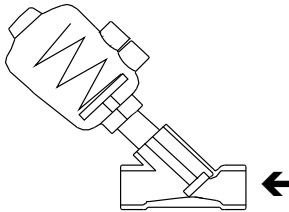

Nominal diameter (port connection)		Actuator size Ø	$K_v$ value water	Pilot pressure min.	Operating pressure max.		
					A (CF A)	A (CF A)	B (CF B)
						Seat seal	
DN	NPS	[mm]	[m <sup>3</sup> /h]	[bar(g)]	PTFE [bar(g)]	PEEK [bar(g)]	PTFE [bar(g)]
10	3/8	40 (C)	3.7	4	15	–	16
		50 (D)	4.0	4.1	16	–	16
		63 (E)	4.3	4.5	25 <sup>1.)</sup>	25 <sup>1.)</sup>	25 <sup>1.)</sup>
15	1/2	40 (C)	3.8	4	15	–	16
		50 (D)	4.2	4.1	16	–	16
		63 (E)	4.5	4.5	25 <sup>1.)</sup>	25 <sup>1.)</sup>	25 <sup>1.)</sup>
20	3/4	40 (C)	7	4	6.5	–	16
		50 (D)	8.5	4.1	11	–	16
		63 (E)	9	4.5	20 <sup>1.)</sup>	16	25 <sup>1.)</sup>
		80 (F)	9	5	25 <sup>1.)</sup>	25 <sup>1.)</sup>	–
25	1	50 (D)	10	4.1	5.2	–	16
		63 (E)	18	4.5	11	–	25 <sup>1.)</sup>
		80 (F)	18	5	25 <sup>1.)</sup>	21 <sup>1.)</sup>	25 <sup>1.)</sup>
32	1 1/4	63 (E)	25	4.5	6	–	25 <sup>1.)</sup>
		80 (F)	27	5	14	–	25 <sup>1.)</sup>
		125 (H)	28	3.2	25 <sup>1.)</sup>	25 <sup>1.)</sup>	–
40	1 1/2	63 (E)	35	4.5	4	–	24 <sup>1.)</sup>
		80 (F)	38	5	9	–	25 <sup>1.)</sup>
		100 (G)	40	4.4	12.5	–	25 <sup>1.)</sup>
		125 (H)	40	4.1	25 <sup>1.)</sup>	25 <sup>1.)</sup>	–
50	2	63 (E)	49	4.5	2.5	–	13
		80 (F)	52	5	5	–	25 <sup>1.)</sup> (20 <sup>2.)</sup> )
		100 (G)	55	4.4	7.2	–	25 <sup>1.)</sup> (20 <sup>2.)</sup> )
		125 (H)	55	5.7	24 <sup>1.)</sup> (20 <sup>2.)</sup> )	20 <sup>1.)</sup>	–
65	2 1/2	80 (F)	77	5	3.5	–	15
		125 (H)	90	5.7	12	10	23 <sup>1.)</sup> (15 <sup>2.)</sup> )
80	3	125 (H)	140	5.7	7.5	–	14 (12.5 <sup>2.)</sup> )

1.) Gunmetal variants are limited to max. 16 bar(g).

2.) According to pressure equipment directive 2014/68/EU for compressible fluids of group 1 (dangerous gases and vapours according to article 4, paragraph (1), c), i), first indent)

**Pilot pressure diagram with flow direction below seat (control function B, seat seal PTFE)**

**Actuator size Ø 40 mm (C)**

Maximum control pressure 10 bar(g)

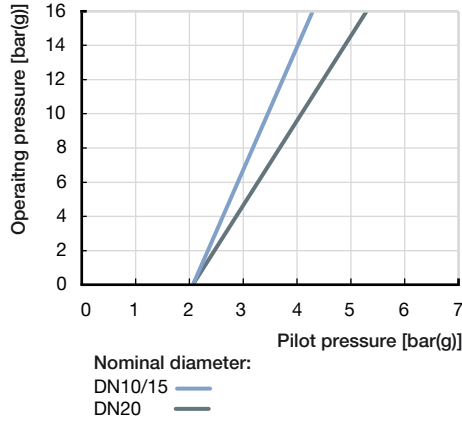

**Actuator size Ø 50 mm (D)**

Maximum control pressure 10 bar(g)

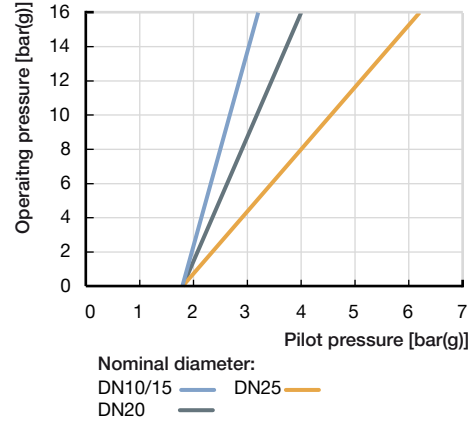

**Actuator size Ø 63 mm (E)**

Maximum control pressure 10 bar(g)

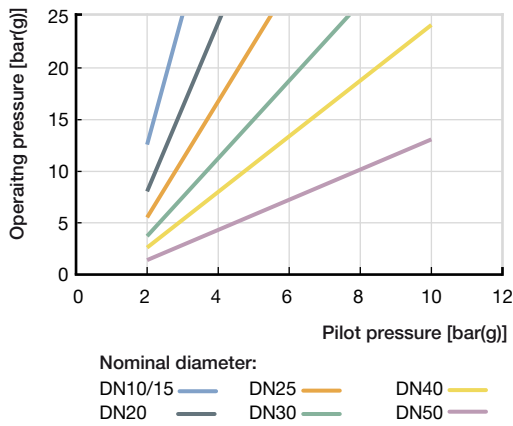

**Actuator size Ø 80 mm (F)**

Maximum control pressure 10 bar(g)

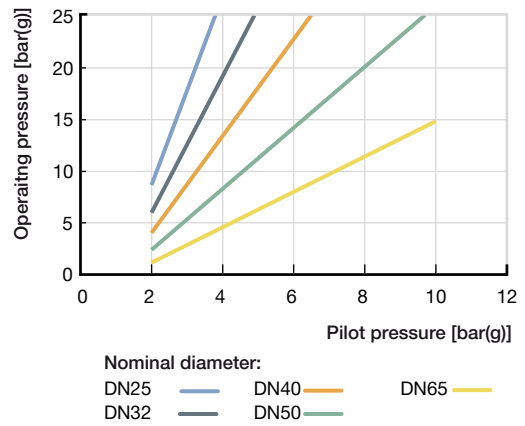

**Actuator size Ø 100 mm (G)**

Maximum control pressure 7 bar(g)

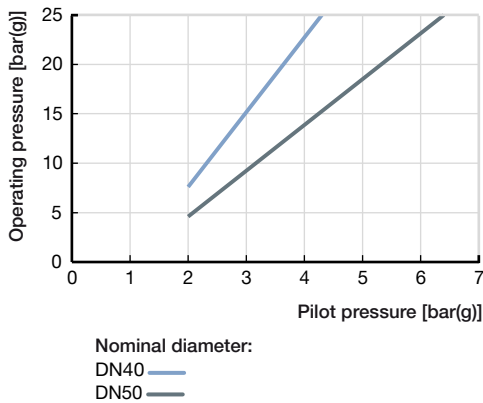

**Actuator size Ø 125 mm (H)**

Maximum control pressure 7 bar(g)

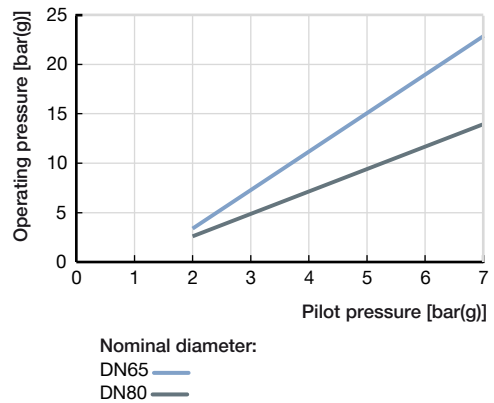

DTS 1000444947 EN Version: S Status: RL (released | freigegeben | validé) printed: 20.03.2024

**Overview of fluidic data with flow above seat (for gases and steam)**

**Note:**

- $K_v$  value [m<sup>3</sup>/h]: Measured with water at +20 °C, 1 bar(g) pressure at valve inlet and free outlet
- Pressure data [bar(g)]: Overpressure to atmospheric pressure

**⚠ WARNING**  
**Risk of damage due to bursting pipes and bursting equipment when the flow is above the seat.**  
**In the case of liquid mediums, water hammer can occur, causing pipes and the device to burst.**  
 Do not use valves with flow above the seat for liquid mediums.

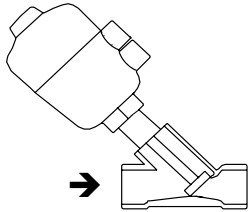

Nominal diameter (port connection)		Actuator size Ø	$K_v$ value water	Operating pressure max.
DN	NPS	[mm]	[m <sup>3</sup> /h]	A (CF A) PTFE [bar(g)]
10	3/8	40 (C)	3.7	16
		50 (D)	4.0	16
15	1/2	40 (C)	3.8	16
		50 (D)	4.2	16
20	3/4	40 (C)	7	16
		50 (D)	8.5	16
25	1	50 (D)	10	16
		63 (E)	18	16
32	1 1/4	63 (E)	25	16
40	1 1/2	63 (E)	35	16
		80 (F)	38	16
50	2	63 (E)	49	16
		80 (F)	52	16
65	2 1/2	80 (F)	77	14
		100 (G)	90	15

DTS 1000444947 EN Version: S Status: RL (released | freigegeben | valide) printed: 20.03.2024



**Pilot pressure diagram with flow direction above seat (control function A, seat seal PTFE)**

**Actuator size Ø 40 mm**

Maximum control pressure 10 bar(g)

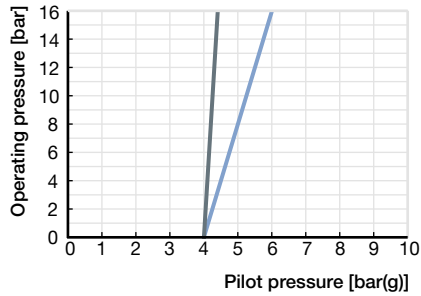

Nominal diameter:  
 DN15 —  
 DN20 —

**Actuator size Ø 50 mm**

Maximum control pressure 10 bar(g)

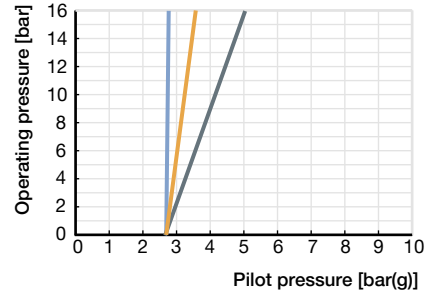

Nominal diameter:  
 DN15 —  
 DN20 —  
 DN25 —

**Actuator size Ø 63 mm**

Maximum control pressure 10 bar(g)

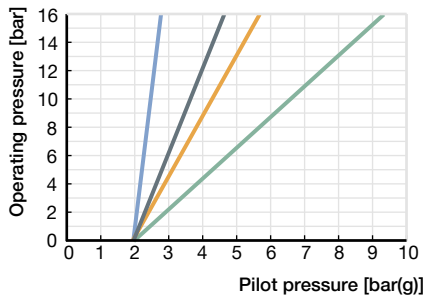

Nominal diameter:  
 DN25 —      DN40 —  
 DN32 —      DN50 —

**Actuator size Ø 80 mm**

Maximum control pressure 10 bar(g)

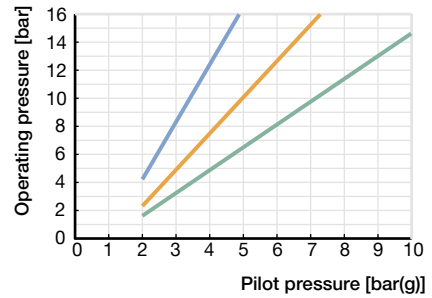

Nominal diameter:  
 DN40 —  
 DN50 —  
 DN65 —

**Actuator size Ø 100 mm**

Maximum control pressure 7 bar(g)

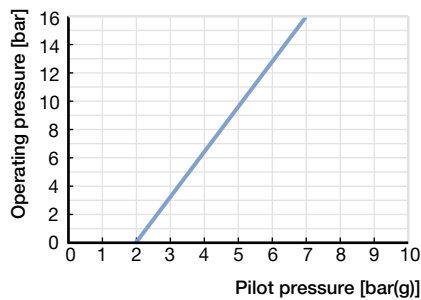

Nominal diameter:  
 DN65 —

DTS 1000444947 EN Version: S Status: RL (released | freigegeben | validé) printed: 20.03.2024

## 7.2. Operating limits

### Operating limits for medium temperature and operating pressure

The operating range of Bürkert process valves is in addition to the maximum operating pressures limited by the nominal pressure according to the relevant standard.

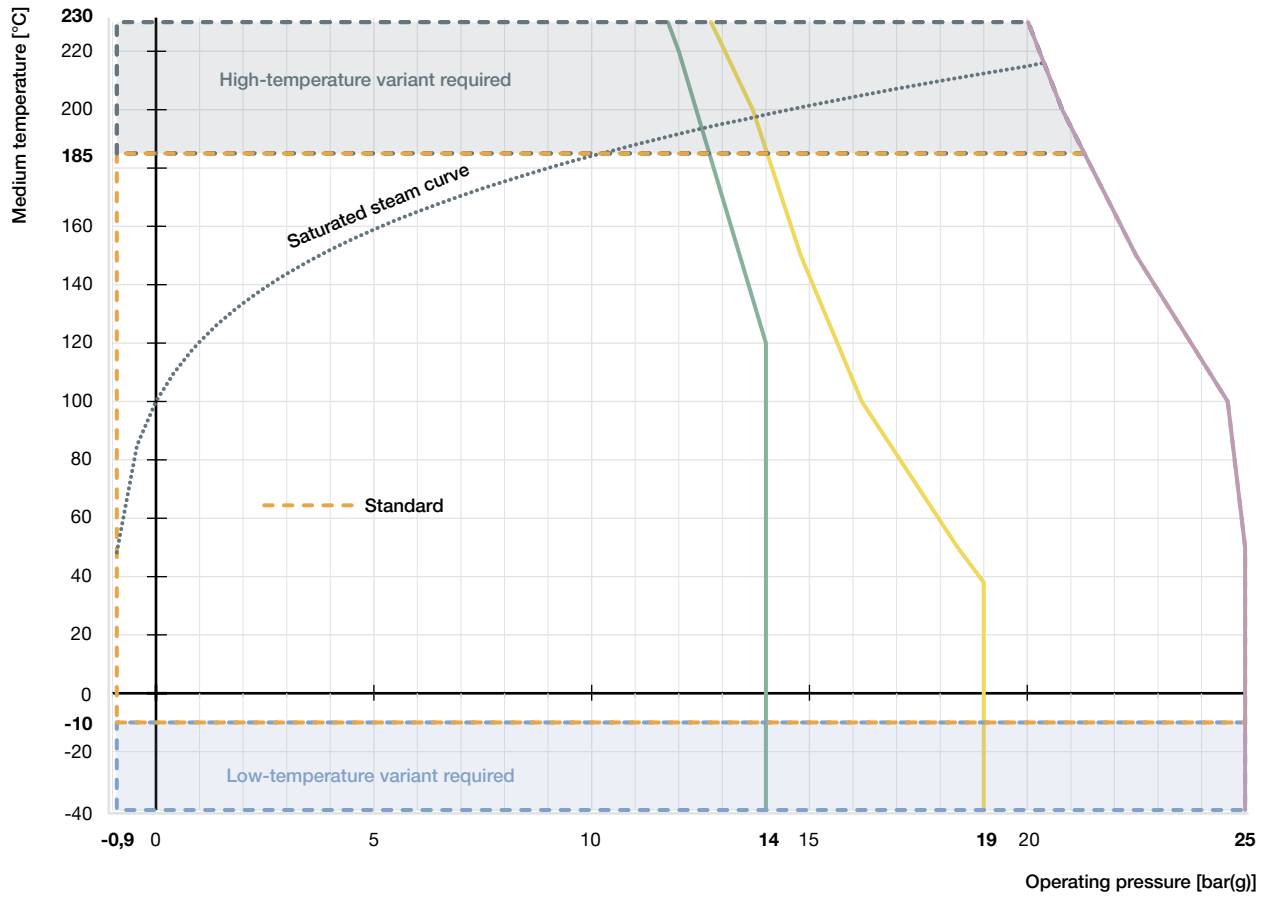

- Operating limits for PN25 according to DIN EN 12516-1
- Operating limits for flange 10K according to JIS B 2220
- Operating limits for Class 150 according to ASME B16.34
- ⋯ Saturated steam curve for water

DTS 1000444947 EN Version: S Status: RL (released | freigegeben | validé) printed: 20.03.2024

**Operating limits for ambient and medium temperature**

**Note:**

For size 40, 50 and 63 PA actuators, the combination of maximum medium temperature and maximum ambient temperature is shown in the following diagram:

**Classic PA actuator**

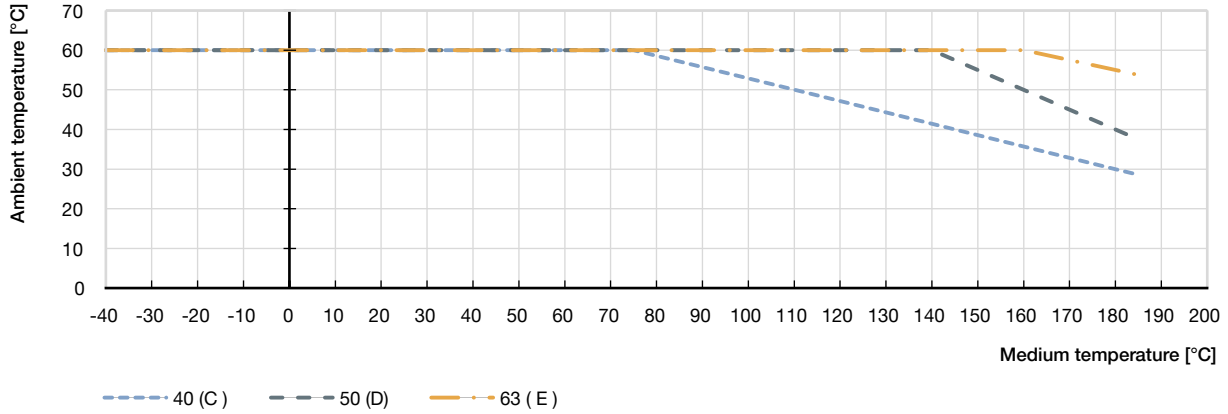

**Classic PPS actuator**

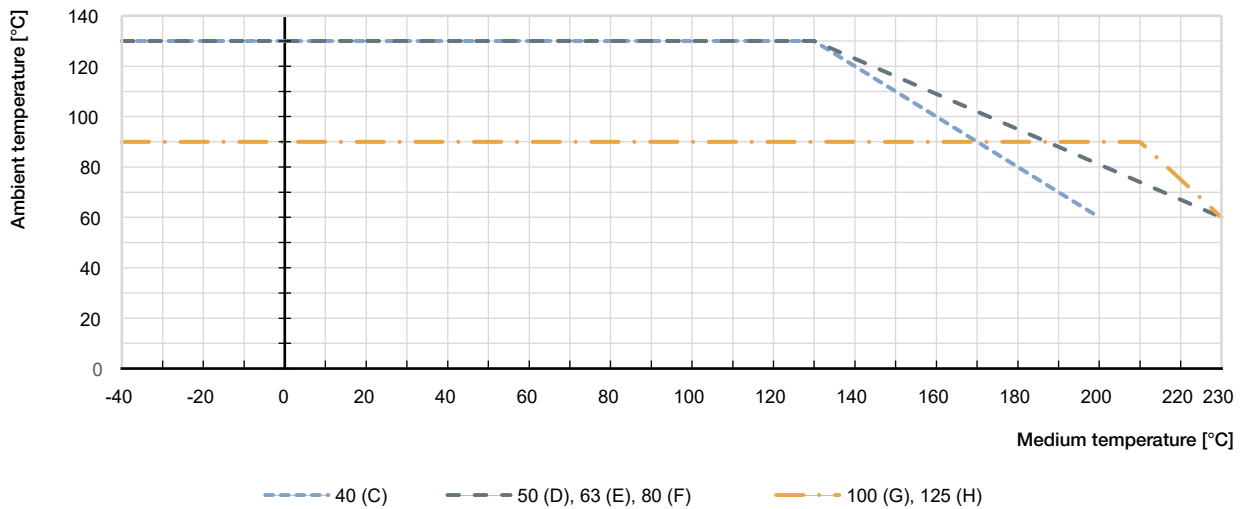

**Operating limits for optional versions**

**High-temperature version**

Thanks to an adaption of the spindle sealing and seat seal in PEEK, this version is suitable for applications with steam, neutral gases and other heat transfer mediums up to +230 °C.

**Water version**

For applications with water up to +200 °C, a special configuration of the spindle seal increases service life significantly. It is recommended for water temperatures starting at +85 °C.

**Vacuum version**

Without leakage bore, this design is suitable for pressures down to -0.9 bar(g).

**Low-temperature version**

Suitable for minimum medium temperatures down to -40 °C

DTS 1000444947 EN Version: S Status: RL (released | freigegeben | validé) printed: 20.03.2024

## 8. Product accessories

<b>Electric position feedback indicator</b>	
<b>Type 8697 ▶ Actuator size Ø 40 (C)...125 (H)</b>	
	<p>The position feedback Type 8697 is designed for integrated mounting on CLASSIC series 20XX process valves, suiting the requirements of hygienic process environments. Mechanical or inductive limit switches register the position of the valve.</p> <p><b>Features</b></p> <ul style="list-style-type: none"> <li>• Compact design</li> <li>• LED position indicator</li> <li>• Mechanical or inductive limit switches for end position registering</li> <li>• Easy-to-clean clean chemically resistant housing featuring IP65/IP67, 4X Rating</li> <li>• Optionally intrinsically safe variant according to IECEx</li> </ul> <p><b>Customer benefits</b></p> <ul style="list-style-type: none"> <li>• Easy and quick installation</li> <li>• High level of signal reliability thanks to self-adjusting limit switches</li> <li>• Minimised space requirement in the plant piping for more flexibility in plant design</li> </ul>
<b>Adaptation for proximity switch</b>	
<b>Type 2XXX ▶</b>	
	<p>Various options for the use of inductive proximity switches are available for the CLASSIC series actuators:</p> <ul style="list-style-type: none"> <li>• Nipple</li> <li>• Support bracket, 1-fold</li> <li>• Support bracket, 2-fold</li> </ul>
<b>Plunger valve 3/2-way direct acting</b>	
<b>Type 6012 ▶ for Actuator size Ø 40 (C)...63 (E), Type 6014 ▶ for Actuator size Ø 50 (D)...125 (H)</b>	
	<p>For easy direct mounting to a pneumatic actuator, a banjo connection with banjo bolt is the ideal solution. An optional manual override allows fast commissioning and optimum maintenance.</p> <p>In conjunction with a cable plug according to DIN EN 175301 - 803 Form A or B, the valves meet protection class IP65.</p> <p><b>Features</b></p> <ul style="list-style-type: none"> <li>• High reliability</li> <li>• Resistant according to IP65</li> </ul> <p><b>Customer benefits</b> Easy and quick installation</p>
<b>Stroke limiter</b>	
<b>Type 2XXX ▶</b>	
	<p>Stroke limitations can be used to limit the minimum and maximum flow rate of the valves.</p> <p>Different variants are available:</p> <ul style="list-style-type: none"> <li>• Maximum stroke limitation</li> <li>• Maximum and minimum stroke limitation with optical position indicator</li> </ul>

DTS 1000444947 EN Version: S Status: RL (released | freigegeben | validé) printed: 20.03.2024

## 9. Networking and combination with other Bürkert products

The angled seat valve Type 2000 can be combined with the feedback positioner Type 8697 to form the valve system On/Off CLASSIC Type 8801-YA.

**Note:**

- For the configuration of further valve systems use the **Product Enquiry Form** (see “10.3. Bürkert Product Enquiry Form” on page 22).
- You order two components and receive a completely assembled and tested valve.



DTS 1000444947 EN Version: S Status: RL (released | freigegeben | validé) printed: 20.03.2024

## 10. Ordering information

### 10.1. Bürkert eShop



#### Bürkert eShop – Easy ordering and quick delivery

You want to find your desired Bürkert product or spare part quickly and order directly? Our online shop is available for you 24/7. Sign up and enjoy all the benefits.

[Order online now](#)

### 10.2. Bürkert product filter



#### Bürkert product filter – Get quickly to the right product

You want to select products comfortably based on your technical requirements? Use the Bürkert product filter and find suitable articles for your application quickly and easily.

[Try out our product filter](#)

### 10.3. Bürkert Product Enquiry Form

**Note:**

Please see our Product Enquiry Form for a full explanation of our specification key.

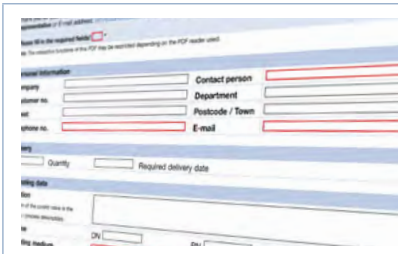

#### Bürkert Product Enquiry Form – Your enquiry quickly and compactly

Would you like to make a specific product enquiry based on your technical requirements? Use our Product Enquiry Form for this purpose. There you will find all the relevant information for your Bürkert contact. This will enable us to provide you with the best possible advice.

[Fill out the form now](#)

DTS 1000444947 EN Version: S Status: RL (released | freigegeben | validé) printed: 20.03.2024

### 10.4. Ordering chart threaded connection

Valve with flow direction below seat

Control function	Nominal diameter (port connection)	Actuator size Ø	K <sub>v</sub> value water	Pilot pressure min.	Operating pressure max.	Article no. PA actuator	Operating pressure max.	Article no.		
	NPS							[mm]	[m <sup>3</sup> /h]	[bar(g)]
<b>DIN ISO 228 - 1</b>					<b>Gunmetal body</b>			<b>Stainless steel body</b>		
<b>A (CF A)</b> see control functions <sup>1.)</sup>	3/8	40 (C)	3.7	4.0	15	344651 ☒	15	342352 ☒	344649 ☒	
	1/2	40 (C)	3.8	4.0	15	342508 ☒	15	345487 ☒	344645 ☒	
		50 (D)	4.2	4.1	16	344665 ☒	16	341191 ☒	344663 ☒	
	3/4	50 (D)	8.5	4.1	11	344662 ☒	11	344660 ☒	344659 ☒	
		63 (E)	9.0	4.5	16	344654 ☒	20	342666 ☒	344652 ☒	
	1	63 (E)	18	4.5	11	344658 ☒	11	344656 ☒	344655 ☒	
		80 (F)	18	5.0	16	344768 ☒	25	342693 ☒	344822 ☒	
	1 1/4	80 (F)	27	5.0	14	344680 ☒	14	340789 ☒	344676 ☒	
		1 1/2	80 (F)	38	5.0	9	344675 ☒	9	343142 ☒	344673 ☒
			125 (H)	40	3.2	16	343138 ☒	16	342695 ☒	o. r.
	2	125 (H)	40	4.1	-	-	25	344989 ☒	o. r.	
		100 (G)	55.0	4.4	7.2	183193 ☒	7.2	344381 ☒	344382 ☒	
			125 (H)	55.0	3.2	10	344411 ☒	10	o. r.	o. r.
	2 1/2	125 (H)	55.0	5.7	-	-	24 (20 <sup>3.)</sup> )	20001172 ☒	o. r.	
		125 (H)	90.0	3.2	5.2	344384 ☒	5.2	344385 ☒	344432 ☒	
125 (H)		90.0	5.7	-	-	12	o. r.	361565 ☒		
3	125 (H)	140	5.7	-	-	7.5	350628 ☒	o. r.		
<b>B (CF B)</b> see control functions <sup>1.)</sup>	3/8	40 (C)	3.7	See diagrams <sup>2.)</sup>	16	344510 ☒	16	344517 ☒	344647 ☒	
	1/2	40 (C)	3.8		16	344641 ☒	16	344642 ☒	344643 ☒	
		50 (D)	4.2		16	344672 ☒	16	344670 ☒	344669 ☒	
	3/4	50 (D)	8.5		16	344668 ☒	16	344667 ☒	344666 ☒	
	1	50 (D)	10		16	344685 ☒	16	344683 ☒	344682 ☒	
	1 1/4	63 (E)	25		16	344681 ☒	25	344687 ☒	344686 ☒	
	1 1/2	63 (E)	35		16	344698 ☒	25	344696 ☒	344695 ☒	
		63 (E)	49.0		13	342965 ☒	13	344386 ☒	344433 ☒	
	2	80 (F)	52		16	344412 ☒	25 (20 <sup>3.)</sup> )	344413 ☒	344459 ☒	
		80 (F)	77.0		15	439038 ☒	15	344387 ☒	344434 ☒	
	3	125 (H)	140		-	-	14 (12.5 <sup>3.)</sup> )	370263 ☒	o. r.	

o. r. = on request

1.) For more information, refer to the chapter "3. Control functions" on page 6.

2.) See diagrams in chapter "Pilot pressure diagram with flow direction below seat (control function B, seat seal PTFE)" on page 15

3.) According to pressure equipment directive 2014/68/EU for compressible fluids of group 1 (dangerous gases and vapours according to article 4, paragraph (1), c), i), first indent)

DTS 1000444947 EN Version: S Status: RL (released | freigegeben | valide) printed: 20.03.2024

**Valve with flow direction above seat**

**Note:**

See diagrams in chapter **“Pilot pressure diagram with flow direction above seat (control function A, seat seal PTFE)”** on page 17.

Control function	Nominal diameter (port connection) NPS	Actuator size Ø [m³/h]	K <sub>v</sub> value water [m³/h]	Operating pressure max. [bar(g)]	Article no.		
					PA actuator	PA actuator	PPS actuator
<b>DIN ISO 228 - 1</b>					<b>Gunmetal body</b>	<b>Stainless steel body</b>	
<b>A (CF A)</b> see control functions <sup>1.)</sup>	3/8	40 (C)	3.7	16	344782 ☒	344516 ☒	o. r.
	1/2	50 (D)	4.2	16	344734 ☒	344761 ☒	344765 ☒
	3/4	40 (C)	7.0	16	344803 ☒	344820 ☒	o. r.
		50 (D)	8.5	16	344741 ☒	344740 ☒	344709 ☒
	1	50 (D)	10.0	16	344763 ☒	344793 ☒	344827 ☒
		63 (E)	18.0	16	344694 ☒	344693 ☒	344692 ☒
	1 1/4	63 (E)	25.0	16	344691 ☒	344700 ☒	344699 ☒
	1 1/2	63 (E)	35.0	16	344703 ☒	344702 ☒	344701 ☒
	2	63 (E)	49.0	16	344383 ☒	344395 ☒	344454 ☒
	2 1/2	80 (F)	77.0	14	344394 ☒	344396 ☒	344457 ☒
100 (G)		90.0	15	344485 ☒	344487 ☒	o. r.	

o. r. = on request

1.) For more information refer to the chapter **“3. Control functions”** on page 6.

Further versions on request	
<p><b>Approval</b> Food processing, drinking water, oxygen, fuel gases, explosion protection</p>	<p><b>Pressure</b> Other versions for operating pressures up to 25 bar(g) Vacuum version down to -0.9 bar(g)</p>
<p><b>Material</b> Seal: NBR, FKM, EPDM</p>	<p><b>Temperature</b> High temperature version up to +230 °C Hot water version up to +200 °C Low temperature version down to -40 °C</p>
<p><b>Process connection</b> Clamp connection, welded connection</p>	

DTS 1000444947 EN Version: S Status: RL (released | freigegeben | validé) printed: 20.03.2024



### 10.5. Ordering chart welded connection

Valve with flow direction below seat

Control function	Nominal diameter (port connection)	Actuator size Ø	Port connection Pipe Ø	Pilot pressure min.	Operating pressure max.	Article no.	
	NPS					[mm]	[mm]
<b>DIN EN ISO 1127 / ISO 4200</b>							
<b>A (CF A)</b> see control functions <sup>1.)</sup>	15	50 (D)	21.3 × 1.6	4.1	16	344388	344473
	20	50 (D)	26.9 × 1.6	4.1	11	344389	344474
	25	63 (E)	33.7 × 2.0	4.5	11	344390	344475
	32	80 (F)	42.4 × 2.0	5	14	344391	344450
	40	80 (F)	48.3 × 2.0	5	9	344392	344483
	50	100 (G)	60.3 × 2.0	4.4	7.2	345012	356461
	65	125 (H)	76.1 × 2.3	3.2	5.2	344588	o. r.
			76.1 × 2.3	5.7	12	20001505	o. r.
<b>B (CF B)</b> see control functions <sup>1.)</sup>	15	50 (D)	21.3 × 1.6	See diagrams <sup>2.)</sup>	16	345485	344478
	20	50 (D)	26.9 × 1.6		16	344405	344479
	25	63 (E)	33.7 × 2.0		25	344406	o. r.
	32	63 (E)	42.4 × 2.0		25	344407	o. r.
	40	63 (E)	48.3 × 2.0		25	344408	353580
	50	63 (E)	60.3 × 2.0		13	345013	o. r.
	65	80 (F)	76.1 × 2.3		15	344609	o. r.
<b>DIN 11850-2</b>							
<b>A (CF A)</b> see control functions <sup>1.)</sup>	15	50 (D)	19 × 1.5	4.1	16	344267	344557
	20	50 (D)	23 × 1.5	4.1	11	344522	344559
	25	63 (E)	29 × 1.5	4.5	11	344523	344540
	32	80 (F)	35 × 1.5	5	14	344524	352462
	40	80 (F)	41 × 1.5	5	9	344525	352468
	50	100 (G)	53 × 1.5	4.4	7.2	344526	352467
	65	125 (H)	70 × 2.0	3.2	5.2	344614	o. r.
			70 × 2.0	5.7	12	20015086	o. r.
<b>B (CF B)</b> see control functions <sup>1.)</sup>	15	50 (D)	19 × 1.5	See diagrams <sup>2.)</sup>	16	344527	352208
	20	50 (D)	23 × 1.5		16	344528	344558
	25	63 (E)	29 × 1.5		25	344530	366314
	32	63 (E)	35 × 1.5		25	344531	352385
	40	63 (E)	41 × 1.5		25	344532	352387
	50	63 (E)	53 × 1.5		13	344533	154903
	65	80 (F)	70 × 2.0		15	344617	o. r.
<b>ASME BPE</b>							
<b>A (CF A)</b> see control functions <sup>1.)</sup>	½	50 (D)	12.7 × 1.65	4.1	16	344549	344547
	¾	50 (D)	19.05 × 1.65	4.1	11	344726	o. r.
	1	63 (E)	25.4 × 1.65	4.5	11	345476	344879
	1½	80 (F)	38.1 × 1.65	5	9	344553	o. r.
	2	100 (G)	50.8 × 1.65	4.4	7.2	344727	o. r.
<b>B (CF B)</b> see control functions <sup>1.)</sup>	½	50 (D)	12.7 × 1.65	See diagrams <sup>2.)</sup>	16	344550	364483
	¾	50 (D)	19.05 × 1.65		16	344583	o. r.
	1	63 (E)	25.4 × 1.65		25	183280	o. r.
	1½	63 (E)	38.1 × 1.65		25	344554	o. r.
	2	63 (E)	50.8 × 1.65		13	344630	o. r.

o. r. = on request

1.) For more information, refer to the chapter "3. Control functions" on page 6.

2.) See diagrams in chapter "Pilot pressure diagram with flow direction below seat (control function B, seat seal PTFE)" on page 15

DTS 1000444947 EN Version: S Status: RL (released | freigegeben | valide) printed: 20.03.2024

**Valve with flow direction above seat**

The following tables refer to valves with stainless steel body, n actuator of PA and Ra inside from ≤3.2 µm.

Control function	Nominal diameter (port connection) NPS	Actuator size Ø [mm]	Port connection Pipe Ø [mm]	Pilot pressure min. [bar(g)]	Operating pressure max. [bar(g)]	Article no.	
						PA actuator	PPS actuator
<b>DIN EN ISO 1127 / ISO 4200</b>							
<b>A (CF A)</b> see control functions <sup>1.)</sup>	15	50 (D)	21.3 × 1.6	See diagrams <sup>2.)</sup>	16	344402	352370
	20	50 (D)	26.9 × 1.6		16	344401	o. r.
	25	63 (E)	33.7 × 2		16	344400	352457
	32	63 (E)	42.4 × 2		16	344397	o. r.
	40	63 (E)	48.3 × 2		16	344398	344480
	50	63 (E)	60.3 × 2.0		16	345014	o. r.
	65	80 (F)	76.1 × 2.3		14	345146	o. r.
<b>DIN 11850 - 2</b>							
<b>A (CF A)</b> see control functions <sup>1.)</sup>	15	50 (D)	19 × 1.5	See diagrams <sup>2.)</sup>	16	342493	344582
	20	50 (D)	23 × 1.5		16	344534	344863
	25	63 (E)	29 × 1.5		16	344535	352203
	32	63 (E)	35 × 1.5		16	344536	352390
	40	63 (E)	41 × 1.5		16	344537	352207
	50	63 (E)	53 × 1.5		16	341778	352461
	65	80 (F)	70 × 2.0		14	344625	367783
<b>ASME BPE</b>							
<b>A (CF A)</b> see control functions <sup>1.)</sup>	½	50 (D)	12.7 × 1.65	See diagrams <sup>2.)</sup>	16	344728	o. r.
	¾	50 (D)	19.05 × 1.65		16	344729	o. r.
	1	63 (E)	25.4 × 1.65		16	344730	344556
	1½	63 (E)	38.1 × 1.65		16	344731	o. r.
	2	63 (E)	50.8 × 1.65		16	344602	o. r.

o. r. = on request

1.) For more information, refer to the chapter "3. Control functions" on page 6.

2.) See diagrams in chapter "Pilot pressure diagram with flow direction above seat (control function A, seat seal PTFE)" on page 17

Further versions on request	
<p><b>Approval</b> Food processing, drinking water, oxygen, fuel gases, explosion protection</p>	<p><b>Pressure</b> Other versions for operating pressures up to 25 bar(g) Vacuum version down to -0.9 bar(g)</p>
<p><b>Material</b> Seal: NBR, FKM, EPDM</p>	<p><b>Temperature</b> High temperature version up to +230 °C Hot water version up to +200 °C Low temperature version down to -40 °C</p>
<p><b>Process connection</b> Clamp connection, threaded connection</p>	



















DTS 1000444947 EN Version: S Status: RL (released | freigegeben | validé) printed: 20.03.2024

## 10.6. Ordering chart clamp connection

### Valve with flow direction below seat

#### Note:

The following tables refer to valves with stainless steel body.

Control function	Nominal diameter (port connection)	Actuator size Ø [mm]	Port connection external Ø [mm]	Pilot pressure min. [bar(g)]	Operating pressure max. [bar(g)]	Article no.	
	DN					PA actuator	PPS actuator
<b>ISO 2852</b>							
<b>A (CF A)</b> see control functions <sup>1.)</sup>	15	50 (D)	34.0	4.1	16	345128 	o. r.
	20	50 (D)	50.5	4.1	11	345129 	o. r.
	25	63 (E)	50.5	4.2	11	345130 	344574 
	32	80 (F)	50.5	5	14	345131 	o. r.
	40	80 (F)	64.0	5	9	345132 	o. r.
	50	100 (G)	77.5	4.4	7.2	345133 	o. r.
<b>B (CF B)</b> see control functions <sup>1.)</sup>	15	50 (D)	34.0	See diagrams <sup>2.)</sup>	16	363929 	o. r.
	20	50 (D)	50.5		16	345134 	o. r.
	25	50 (D)	50.5		16	363930 	o. r.
	32	63 (E)	50.5		16	363933 	o. r.
	40	63 (E)	64.0		16	363940 	o. r.
	50	63 (E)	77.5		13	363942 	o. r.
<b>ASME BPE</b>							
<b>A (CF A)</b> see control functions <sup>1.)</sup>	½	50 (D)	25.0	4.1	16	344632 	o. r.
	¾	50 (D)	25.0	4.1	11	344633 	o. r.
	1	63 (E)	50.5	4.2	11	344634 	o. r.
	1½	80 (F)	50.5	5	9	344635 	o. r.
	2	100 (G)	64.0	4.4	7.2	344636 	o. r.
<b>B (CF B)</b> see control functions <sup>1.)</sup>	½	50 (D)	25.0	See diagrams <sup>2.)</sup>	16	o. r.	o. r.
	¾	50 (D)	25.0		16	o. r.	o. r.
	1	50 (D)	50.5		16	o. r.	o. r.
	1½	63 (E)	50.5		16	o. r.	o. r.
	2	63 (E)	64.0		13	o. r.	o. r.

o. r. = on request

1.) For more information, refer to the chapter "3. Control functions" on page 6.

2.) See diagrams in chapter "Pilot pressure diagram with flow direction below seat (control function B, seat seal PTFE)" on page 15





Valve with flow direction above seat

Control function	Nominal diameter (port connection)	Actuator size Ø	Port connection external Ø	Pilot pressure min.	Operating pressure max.	Article no.	
	DN					[mm]	[mm]
<b>ISO 2852</b>							
<b>A (CF A)</b> see control functions <sup>1)</sup>	15	50 (D)	34.0	See diagrams <sup>2)</sup>	16	345135	345145
	20	50 (D)	50.5		16	345136	o. r.
	25	63 (E)	50.5		16	345137	o. r.
	32	63 (E)	50.5		16	345138	o. r.
	40	63 (E)	64.0		16	345139	o. r.
	50	63 (E)	77.5		16	345140	431027
<b>ASME BPE</b>							
<b>A (CF A)</b> see control functions <sup>1)</sup>	½	50 (D)	25.0	See diagrams <sup>2)</sup>	16	344721	o. r.
	¾	50 (D)	25.0		16	344722	o. r.
	1	63 (E)	50.5		16	344723	o. r.
	1½	63 (E)	50.5		16	344724	o. r.
	2	63 (E)	64.0		16	344725	o. r.

o. r. = on request

1.) For more information, refer to the chapter "3. Control functions" on page 6.

2.) See diagrams in chapter "Pilot pressure diagram with flow direction above seat (control function A, seat seal PTFE)" on page 17

Further versions on request	
 <p><b>Approval</b> Food processing, drinking water, oxygen, fuel gases, explosion protection</p>	 <p><b>Pressure</b> Other versions for operating pressures up to 25 bar(g) Vacuum version down to -0.9 bar(g)</p>
 <p><b>Material</b> Seal: NBR, FKM, EPDM</p>	 <p><b>Temperature</b> High temperature version up to +230 °C Hot water version up to +200 °C Low temperature version down to -40 °C</p>
 <p><b>Process connection</b> Clamp connection acc. to DIN 32676, welded connection, threaded connection</p>	

10.7. Ordering chart accessories

Accessories for 3/2-way pilot valves with banjo bolts

Note:

- Seal material FKM / NBR
- For complete program see data sheet [Type 7012](#) ▶, [Type 6014](#) ▶, [Type 2507](#) ▶, [Type 2518](#) ▶

Valves for actuator size Ø	Type	Pilot air port	Working port (banjo bolt)	Q <sub>Nn</sub> value air	Pressure range	Electrical coil connection Industry standard	Power consumption	Article no.			
								Voltage/Frequency		Cable plug	
								024 V/DC	230 V/50	12...24 AC/DC with LED	0...250 AC/DC
[mm]				[l/min]	[bar(g)]		[W]	[V]	[V]	[V]	[V]
40 (C)  50 (D)... 63 (E)	7012	Thread G ¼	Thread G ⅛	48	0...10	Type 2507 Form B	4	390831	390835	423849	423845
		Push-in connector Ø 6 mm						390880	390887		
		Thread G ¼	Thread G ¼					390850	390854		
		Push-in connector Ø 6 mm						390905	390911		
50 (D)... 125 (H)	6014P	Thread G ¼	Thread G ¼	120	0...10	Type 2518 Form A	8	334870	389550	314812	314802

DTS 1000444947 EN Version: S Status: RL (released | freigegeben | valide) printed: 20.03.2024

DISTRIBUTED BY



ENTERPRISES LTD.

1-800-361-5361